



Mercedes-Benz

eSPRINTER.

Electric Chassis Cab model.

Prices effective from January 2026





RETURN TO START

Contents

> Summary	3
> MBUX	4
> The eSprinter PRO	5
> The eSprinter SELECT	6
> List price summary	7
> Mercedes-Benz Finance Options	8
> Equipment overview	9
> Colours and upholstery	18
> Charging information	20
> Technical data	21
> Mercedes-Benz Vans and the environment	26
> The Mercedes-Benz App	27
> Approved Used	28
> Integrated Service Package (ISP)	29
> Service 24: Demand more	30

Please note

This document provides information about the model range line-up and specifications of the eSprinter. It also contains key details about options, economy and performance of variants. Details are correct at time of publication and are subject to revision without notice. Any images used in this document may not reflect UK specification and are for illustrative purposes only. Images may show optional equipment which does not form part of UK standard specification.

The New eSprinter Summary.



RETURN TO START

2 Vehicle types	Panel Van & Chassis
2 Battery sizes	81kWh & 113kWh
2 Motors	100kW & 150kW

1 Charging Configuration	AC: 11kW with DC: 115kW**
2 Vehicle lengths	L2 & L3
2 Trim levels	PRO or SELECT



81/113kWh Chassis



81/113kWh Panel Van

All-electric WLTP combined range, full charge
169 - 274 miles*

80% charge top-up in just
34-42 minutes*

*81kWh - 113kWh chassis cab



CCS rapid charging port, 115kW max. capacity.



MBUX Navigation and Live Traffic Information.



Multi-function steering wheel.

Electrical WLTP range for the eSprinter chassis 81kWh - 113kWh battery range in miles (km): 169 (272) - 274 (441). Electrical consumption in kWh/100 km: 28.0 - 32.8 Combined CO₂ emissions in g/km: 0.

Figures correct as of January 2026. The indicated values were determined according to the prescribed measurement method - Worldwide Harmonised Light Vehicle Test Procedure (WLTP). Battery Electric Vehicles (BEV) require mains electricity for charging, range figures determined with the battery fully charged. Figures shown are for comparability purposes; only compare with other cars tested to the same technical procedure (WLTP). Figures may not reflect real life driving results, which will depend upon a number of factors including the starting charge of the battery, factory-fitted options, accessories fitted (post registration), variations in weather, driving styles and vehicle load. Further information about the test used to establish range, power consumption and CO₂ figures can be found at <http://www.mercedes-benz.co.uk/WLTP>. For real time data visit https://voc.mercedes-benz.com/voc/gb_en. **Charging times are subject to the power available at the location where the vehicle will be charged as well as external factors such as temperature and type of cable and charger used.



RETURN TO START

MBUX – the Mercedes-Benz User Experience infotainment system.

The state-of-the-art MBUX technology comes with a high resolution 10.25" touchscreen fitted as standard, offering intuitive touch control and a wealth of features.

With the latest software, all eSprinter-specific settings, such as charging, pre-conditioning or navigation with **Electric Intelligence**, can now be made not only via the instrument cluster, but also via the touchscreen or voice assistant.

Standard features

- High-resolution 10.25-inch touchscreen
- AM/FM radio with dual tuner
- DAB radio
- Bluetooth connectivity with audio streaming
- LINGUATRONIC voice control with optimised, intuitive voice assistant
- Seat-related voice recognition for driver and front passenger³
- Extensive personalization options with up to seven profiles²
- Over-the-air (OTA) updates²
- Wi-Fi hotspot
- Wireless remote UI connection for e.g. Apple CarPlay and Android Auto⁴
- Online music^{1,2}: Tidal, Amazon Music, Spotify
- Multimedia interface with three backlit 18W PPS USB-C ports
- 2-way front speakers
- Volume settings for audio and phone
- Centre-fill speakers for improved sound quality and voice output
- Digital instruction manual

1 Service Entertainment Package required

2 via The Mercedes-Benz App

3 only together with comfort overhead control panel

4 Apple CarPlay and Android Auto is only available in conjunction with E4S – Digital Extra: Smartphone Integration – Requires pairing of the vehicle with a Mercedes-Benz ID





RETURN TO START

The eSprinter PRO model.

Standard features for the eSprinter PRO include:

Exterior

- 16-inch steel wheels
- Heated and electrically adjustable mirrors
- Extended mirror bracket
- Resistance-optimised tyres

Interior

- Height and rake adjustable, multifunction steering wheel
- Heated seat for driver
- Armrest for driver's seat
- Co-driver's double seat
- TEMPMATIC air conditioning semi-automatic
- Shelf above windscreen
- Stowage compartment underneath cockpit
- 5V USB socket
- Maturin black fabric
- Driver camera

Safety and Driver Assistance

- Active Brake Assist
- Pre-wiring reversing camera
- Pre-installation Blind Spot Assist
- Sideguard Assist
- Crosswind Assist
- Active Lane Keeping Assist
- Intelligent Speed Assistant
- ATTENTION ASSIST
- Hill-Start Assist
- Cruise Control
- Headlight assistant
- Tyre pressure monitoring wireless
- Driver and Co-driver airbags
- Rain sensor
- Breakdown management
- Alarm and double locks

Technology & Charging

- MBUX multimedia system
- Digital Extra: Smartphone Integration
- Pre-installations electrical system, PSM
- Pre-installation for switch panel
- Pre-entry climate control
- 8m charging cable mode 3 (type 2, 3x32A)
- AC charging 11kW/DC charging 115kW



Government OZEV grant of up to £5,000

The eSprinter is eligible for a Government OZEV grant that gives businesses 35% off the purchase price, up to a maximum of £5,000*.



Basic recommended list price (ex.VAT) for the 81kWh eSprinter 314 Chassis L3 PRO

£51,910

➤ [Arrange a test drive at your nearest Dealership](#)

* Vehicle purchase price is calculated on base vehicle only (excluding any optional equipment), it excludes delivery charges and first registration fee. The grant will be applied after any vehicle discount has been offered and includes VAT and number plate costs. For more information, visit: <https://www.gov.uk/plug-in-car-van-grants>



The eSprinter SELECT model.



RETURN TO START

Upgrade from PRO to SELECT to get all of the additional equipment listed below:

Exterior

- Front mud flaps

Interior

- Leather steering wheel
- Comfort driver's seat
- Lumbar support for driver's seat
- Convenience head restraint for driver's seat
- Cup holders in front
- Hinged lid for stowage compartment

Technology & Charging

- Charging package, dashboard
- Highbeam Assist
- LED High Performance headlamps



Government OZEV grant of up to £5,000

The eSprinter is eligible for a Government OZEV grant that gives businesses 35% off the purchase price, up to a maximum of £5,000*.



Basic recommended list price (ex.VAT) for the 81kWh eSprinter 320 Chassis L3 SELECT

£55,655

▶ Arrange a test drive at your nearest Dealership

* Vehicle purchase price is calculated on base vehicle only (excluding any optional equipment), it excludes delivery charges and first registration fee. The grant will be applied after any vehicle discount has been offered and includes VAT and number plate costs. For more information, visit: <https://www.gov.uk/plug-in-car-van-grants>



List Price Summary.



RETURN TO START

Vehicle Model Description	Powertrain	CO ₂ emissions, WLTP	Basic Recommended Retail Price (Ex. VAT)	Total Recommended Retail Price (Inc. VAT)
81kWh eSprinter 314 Chassis L2 PRO	Battery electric vehicle, RWD, 100kW Motor, Electric range 170 miles ¹ WLTP combined	0g/km	£51,980	£62,376
81kWh eSprinter 314 Chassis L3 PRO	Battery electric vehicle, RWD, 100kW Motor, Electric range 169 miles ¹ WLTP combined	0g/km	£51,910	£62,292
81kWh eSprinter 320 Chassis L2 PRO	Battery electric vehicle, RWD, 150kW Motor, Electric range 171 miles ¹ WLTP combined	0g/km	£53,095	£63,714
81kWh eSprinter 320 Chassis L3 PRO	Battery electric vehicle, RWD, 150kW Motor, Electric range 170 miles ¹ WLTP combined	0g/km	£53,020	£63,624
81kWh eSprinter 320 Chassis L2 SELECT	Battery electric vehicle, RWD, 150kW Motor, Electric range 171 miles ¹ WLTP combined	0g/km	£55,730	£66,876
81kWh eSprinter 320 Chassis L3 SELECT	Battery electric vehicle, RWD, 150kW Motor, Electric range 170 miles ¹ WLTP combined	0g/km	£55,655	£66,786
81kWh eSprinter 414 Chassis L2 PRO	Battery electric vehicle, RWD, 100kW Motor, Electric range 187 miles ¹ WLTP combined	0g/km	£53,855	£64,626
81kWh eSprinter 414 Chassis L3 PRO	Battery electric vehicle, RWD, 100kW Motor, Electric range 187 miles ¹ WLTP combined	0g/km	£53,790	£64,548
81kWh eSprinter 420 Chassis L2 PRO	Battery electric vehicle, RWD, 150kW Motor, Electric range 188 miles ¹ WLTP combined	0g/km	£54,970	£65,964
81kWh eSprinter 420 Chassis L3 PRO	Battery electric vehicle, RWD, 150kW Motor, Electric range 188 miles ¹ WLTP combined	0g/km	£54,900	£65,880
113kWh eSprinter 414 Chassis L3 PRO	Battery electric vehicle, RWD, 100kW Motor, Electric range 272 miles ¹ WLTP combined	0g/km	£66,125	£79,350
113kWh eSprinter 420 Chassis L3 PRO	Battery electric vehicle, RWD, 150kW Motor, Electric range 274 miles ¹ WLTP combined	0g/km	£67,070	£80,484
113kWh eSprinter 420 Chassis L3 SELECT	Battery electric vehicle, RWD, 150kW Motor, Electric range 274 miles ¹ WLTP combined	0g/km	£69,710	£83,652

[†] Technical data of the eSprinter in this publication are preliminary values and were determined internally in accordance with the WLTP certification methods. There are currently no confirmed values from TÜV, nor is there an EC type approval or a certificate of conformity with official values. Deviations between this data and the official values are possible. UK range figures may vary and these will be published when available.

Government OZEV grant of up to £5,000

The eSprinter is eligible for a Government OZEV grant that gives businesses 35% off the purchase price, up to a maximum of £5,000*.



* Vehicle purchase price is calculated on base vehicle only (excluding any optional equipment), it excludes delivery charges and first registration fee. The grant will be applied after any vehicle discount has been offered and includes VAT and number plate costs. For more information, visit: <https://www.gov.uk/plug-in-car-van-grants>

This document is for guidance only and must be used in conjunction with a configuration tool prior to final specification decisions and vehicle quotations being prepared and accepted. List prices are quoted ex-factory unless otherwise stated. Delivery charges excluding VAT will be added to model prices quoted in this document. Prices based on standard finish paint choice. Mercedes-Benz Vans UK and authorised Dealers reserve the right to alter specification and vary prices without notice. The availability of options may depend on the chosen base vehicle and other optional equipment specified, and should be confirmed with your Mercedes-Benz Vans Dealer prior to order placement. VAT is calculated at the standard rate of 20%. Mercedes-Benz Vans UK Ltd, Tongwell, Milton Keynes MK15 8BA.



RETURN TO START

Mercedes-Benz Finance Options.

Choose an agreement that suits you with Mercedes-Benz Finance.

At Mercedes-Benz Finance we understand what it takes to run a modern-day business. Because of this, we have a number of finance options ready to suit your business needs.

Agility (Personal Contract Plan)

Agility (Personal Contract Plan) is our most flexible method of financing. You drive the vehicle over a fixed term, with fixed monthly payments. And at the end of the agreement, you decide whether you want to:

- Buy another Mercedes-Benz.
- Purchase your van by paying the Optional Purchase payment (balloon) and Option to Purchase Fee.
- Return it to us.

As a business customer, your vehicle can also appear as an asset on your balance sheet.

[For more information about Agility.](#)

Hire Purchase

A straightforward route to ownership. This product allows you to spread the overall cost of your Mercedes-Benz over a fixed term.

As a business customer, your vehicle can also appear as an asset on your balance sheet.

[For more information on Hire Purchase.](#)

Operating Lease

A solution for those who want to drive one of our vehicles over a specific term, with fixed monthly rentals and without the commitment of ownership of the vehicle.

As a business customer, your vehicle can also appear as an asset on your balance sheet.

[For more information on Operating Lease.](#)

Contract Hire

A solution for those who want to drive one of our vans over a specific term, with fixed monthly rentals and without the need to commit to ownership of the vehicle. This includes the cost of your Vehicle Excise Duty (also known as Road Fund Licence) for the duration of your agreement.

As a business customer, your vehicle can also appear as an asset on your balance sheet.

[For more information on Contract Hire.](#)

Finance Lease

Finance Lease gives you the ability to enjoy driving a Mercedes-Benz Van for a fixed time without the option of ownership. With this option you lease your vehicle for a fixed period and for fixed monthly rentals.

As a limited company or PLC customer, your vehicle can also appear as an asset on your balance sheet.

[For more information on Finance Lease.](#)

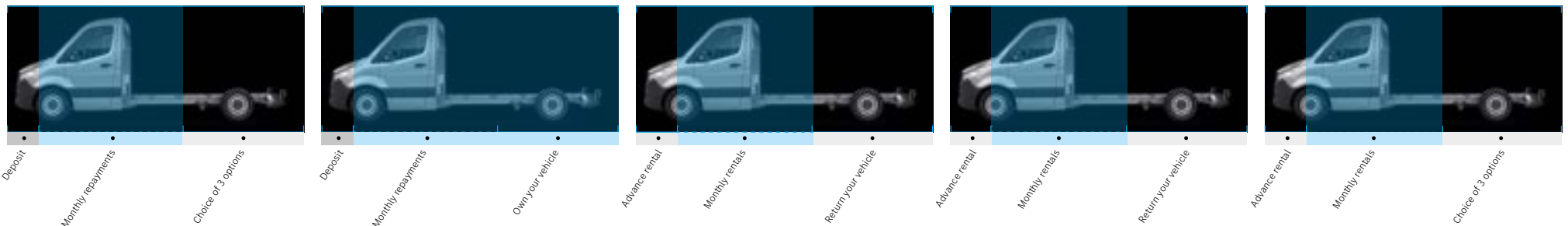

[For more information about our finance options](#)

Equipment (standard and optional overview).



RETURN TO START

Every eSprinter model comes with a host of standard features, plus a range of optional equipment and packages you can add to enhance your van.

Key: ● Standard ○ Optional — Not available

Category	Option Description	Option code	PRO	SELECT	Basic Price exc. VAT	Basic Price inc. VAT
Packages	Winter package Includes wet wiper system (FM3), seat heating for co-driver (H15) and heated seat for driver (H16).	F2W	○	○	£375.00	£450.00
	Winter Package Plus Includes wet wiper system (FM3), seat heating for co-driver (H15) and heated seat for driver (H16), Electrically powered hot-air auxiliary heater (HH2), Steering wheel heating (CK8), Heat insulation (H04); in combination with CL3 only.	P3Z	○	○	£620.00	£744.00
	Maintenance package Includes 4 services: 2 Major and 2 Minor	JE1	●	●	—	—
	Comfort drivers seat package Includes Luxury driver's seat (SB1), Luxury head restraint for driver (SK0), Lumbar support for driver's seat (SE5), Armrest for driver's seat (S22), Armrest, driver and front passenger door (S28).	P2N	○	○	£330.00	£396.00
	Comfort Co-drivers seat package Includes Luxury front passenger's seat (SB2), Luxury head restraint for front passenger (SK1), Lumbar support for front passenger's seat (SE4), Armrest for front passenger's seat (S25)	P2O	○	○	£290.00	£348.00
Paint	Bumpers/detachable body parts painted body colour	CM2	○	○	£530.00	£636.00
	Front bumper painted in vehicle colour	CN3	○	○	£415.00	£498.00
Doors	Door closing monitor and immediate locking	FD1	○	○	£110.00	£132.00
	Cowl and doors	F28	○	○	-£125.00	-£150.00
Driver Assistance	Hill-Start ASSIST	E07	●	●	—	—
	Active Distance Assist DISTRONIC Automatically maintains the distance to vehicles in front. The system accelerates the vehicle by itself and brakes it with a maximum of half the vehicle's braking power in order to maintain a safe distance.	ET4	○	○	£680.00	£816.00
	WET WIPER SYSTEM	FM3	○	○	£130.00	£156.00
	Provision, electrics, reversing aid	FR7	○	○	£85.00	£102.00
	Pre-wiring reversing camera w. int. mirror display	FV1	●	●	—	—
	Pre-installation, Blind Spot Assist, bodybuilder	J1V	●	●	—	—
	Acoustic Presence Indicator All our electric vehicles come as standard with an external acoustic warning to alert pedestrians or cyclists at speeds under 19 mph.	J2A	●	●	—	—

Changes to individual option availability and combinations may occur depending on vehicle specification choices and the continuing evolution and adaptation of our product range. These changes may not be immediately reflected in this document as they occur, but will be introduced at the next revision opportunity.

Equipment (standard and optional overview).

● Standard ○ Optional — Not available



RETURN TO START

Category	Option Description	Option code	PRO	SELECT	Basic Price exc. VAT	Basic Price inc. VAT
Driver Assistance (cont.)	Blind Spot ASSIST Helps when changing lanes and reversing. If a vehicle is detected, a warning sign in a red triangle appears in the corresponding exterior mirror.	JA7	○	○	£560.00	£672.00
	Crosswind ASSIST Detects strong crosswinds and helps the driver to remain in their lane by autonomous targeted braking intervention.	JA8	●	●	—	—
	Traffic Sign ASSIST	JA9	○	○	£355.00	£426.00
	Active Lane Keeping ASSIST Warns the driver if lane markings are crossed unintentionally.	JB4	●	●	—	—
	Rain sensor	JF1	●	●	—	—
	Moving Off Information System (standard on N2 vans)	JF7	●	●	£375.00	£450.00
	Intelligent Speed Assistant Displays the current speed limit in the driver's direct field of vision in the instrument cluster.	JS2	●	●	—	—
	Sideguard Assist	JT7	●	●	—	—
	Preinstallation for remaining distance recorder	JV5	○	○	£75.00	£90.00
	ATTENTION ASSIST With the help of numerous parameters, the ATTENTION ASSIST function can detect typical signs of drowsiness and warn the driver.	JW8	●	●	—	—
	Comfort overhead control panel LED interior lighting including cab downlighting and co-/driver reading lamps; also includes a convenient spectacles compartment.	LC4	●	●	—	—
	Cruise control Includes speed limiter function. Operated via a lever ergonomically positioned on the left of the steering column.	MS1	●	●	—	—
	Tachograph control under dashboard, co-driver side	J2B	○	○	—	—
	Pre-installation, intelligent tachograph, EU	J4V	○	○	£435.00	£522.00
	Intelligent tachograph, EU (standard on 4.25T variants)	JD6	○	○	£990.00	£1,188.00
	Speed limit 8 km/h, reverse gear	MA3	○	○	£170.00	£204.00
	Speed limiter, 100 km/h	MD2	○	○	£170.00	£204.00
	Linear speed limiter 120 km/h (standard on 3.5T variants)	MD3	●	●	£170.00	£204.00
	Linear speed limiter 90 km/h EG (standard on 4.25T variants)	MD4	○	○	—	—
Speed limiter, 110 km/h	MK0	○	○	£170.00	£204.00	
Speed limiter, 80 km/h	MK5	○	○	£170.00	£204.00	

Changes to individual option availability and combinations may occur depending on vehicle specification choices and the continuing evolution and adaptation of our product range. These changes may not be immediately reflected in this document as they occur, but will be introduced at the next revision opportunity.

Equipment (standard and optional overview).

● Standard ○ Optional — Not available



RETURN TO START

Category	Option Description	Option code	PRO	SELECT	Basic Price exc. VAT	Basic Price inc. VAT
Heating and Ventilation	Heat insulation	H04	○	○	£125.00	£150.00
	Pre-entry climate control	H1K	●	●	—	—
	Energy-saving mode, climate control	H2K	○	○	—	—
	Electrically powered hot-air auxiliary heater	HH2	●	●	—	—
	THERMOTRONIC automatic climate control	HH4	○	○	£550.00	£660.00
	Air con., semi-autom. controlled, TEMPMATIC	HH9	●	●	—	—
	Windscreen, heated	F49	○	○	£385.00	£462.00
Steering wheel	Multifunction steering wheel	C6L	●	●	—	—
	Steering wheel heating	CK8	○	○	£155.00	£186.00
	Height and rake adjustable steering wheel	CL1	●	●	—	—
	Leather steering wheel	CL3	○	●	£215.00	£258.00
Brakes	Electrical parking brake	B25	●	●	—	—
	Active Brake ASSIST Can detect the danger of a collision with the vehicle ahead, stationary traffic and pedestrians by reacting with a visual and audible warning – braking automatically if there is no driver reaction.	BA3	●	●	—	—
	HOLD function	BH1	●	●	—	—
Windows and Mirrors	Rear wall window	F35	○	○	£170.00	£204.00
	Heat-insulating glass w.band filter on windscreen	H21	●	●	—	—
	Rear mirror inside	F61	○	○	£65.00	£78.00
	Electrically foldable exterior mirrors	F64	○	○	—	—
	Exterior mirror heated and electr. adjustable	F68	●	●	—	—
	Extended mirror bracket	FS1	●	●	—	—
	Extra-long mirror bracket	FS2	○	○	£65.00	£78.00
	Large mirror head	FT1	○	○	£45.00	£54.00
	Exterior mirrors without indicators	FU5	○	○	—	—
Pre-installation for digital rear-view mirror	F85	○	○	£780.00	£936.00	

Changes to individual option availability and combinations may occur depending on vehicle specification choices and the continuing evolution and adaptation of our product range. These changes may not be immediately reflected in this document as they occur, but will be introduced at the next revision opportunity.

Equipment (standard and optional overview).

● Standard ○ Optional — Not available



RETURN TO START

Category	Option Description	Option code	PRO	SELECT	Basic Price exc. VAT	Basic Price inc. VAT
Battery	AGM battery, 12 V 70 Ah (standard on 3.5T variants)	ED1	●	●	—	—
	heavy-duty battery (standard on 4.25T variants)	ED4	○	○	£125.00	£150.00
	Battery main switch single-pole	E30	○	○	£135.00	£162.00
	Disconnecting relais if auxiliary battery	E36	○	○	£135.00	£162.00
	Starting aid contact	ES0	●	●	—	—
	Additional battery f. retrofit consumers, interior	E2I	○	○	£310.00	£372.00
Body build	Pre-installation DSP box	E3D	○	○	£85.00	£102.00
	Preinstallation for switch panel	E3J	●	●	—	—
	Preinstallation for central locking on body doors	EA5	○	○	£50.00	£60.00
	Extension of PSM standard contact	E5M	○	○	£75.00	£90.00
	Parameterizable special module	ED5	○	○	£475.00	£570.00
	Preinstallations electrical system, PSM	ED8	●	●	—	—
	Terminal strip for electrical connection	EK1	●	●	—	—
	Pre-fittings for multi-tone horn unit	JV7	○	○	—	—
	Preinstallation for rotating beacon lamp	LV1	○	○	£110.00	£132.00
Seating	Seat heating for co-driver	H15	○	○	£310.00	£372.00
	Heated seat for driver	H16	●	●	—	—
	Driver's seat	S02	●	—	—	—
	Adjustable co-driver's seat	S04	○	○	£95.00	£114.00
	Armrest for driver's seat	S22	●	●	—	—
	Co-driver's seat double seat	S23	●	●	—	—
	Armrest for co-driver's seat	S25	○	○	£80.00	£96.00
	Armrest, driver's and co-driver's door	S28	○	○	£60.00	£72.00
	Armrests on both sides for driver	S36	○	○	£160.00	£192.00
	Armrests on both sides for front passenger	S38	○	○	£160.00	£192.00
	Seat belts orange, driver and co-driver	S62	○	○	£40.00	£48.00

Changes to individual option availability and combinations may occur depending on vehicle specification choices and the continuing evolution and adaptation of our product range. These changes may not be immediately reflected in this document as they occur, but will be introduced at the next revision opportunity.

Equipment (standard and optional overview).

● Standard ○ Optional – Not available



RETURN TO START

Category	Option Description	Option code	PRO	SELECT	Basic Price exc. VAT	Basic Price inc. VAT
Seating (cont.)	Reinforced seat base	S86	○	○	£130.00	£156.00
	Driver's seat frame, low	S87	○	○	£35.00	£42.00
	Co-driver's seat frame, low	S88	○	○	£35.00	£42.00
	Deletion, co-driver's seat	S91	○	○	-£125.00	-£150.00
	Seat base for front passenger's seat not provided	S99	○	○	–	–
	Comfort driver's seat	SB1	○	●	£180.00	£216.00
	Comfort co-driver's seat	SB2	○	○	£180.00	£216.00
	Suspension seat, comfort version, driver's seat	SB3	○	○	£600.00	£720.00
	Suspension seat, comfort version, co-driver's seat	SB4	○	○	£600.00	£720.00
	Driver's seat plus	SB9	○	○	£30.00	£36.00
	Lumbar support, co-driver's seat	SE4	○	○	£95.00	£114.00
	Lumbar support, driver's seat	SE5	○	●	£95.00	£114.00
	Driver's seat electrically adjustable	SF1	○	○	£1,225.00	£1,470.00
	Co-driver's seat electrically adjustable	SF2	○	○	£1,225.00	£1,470.00
	Convenience head restraint, driver's seat	SK0	○	●	£70.00	£84.00
	Convenience head restraint, co-driver	SK1	○	○	£140.00	£168.00
	Co-driver's seat	SL1	○	–	–	–
	Swivel base for driver' seat	SR8	○	○	£385.00	£462.00
Swivel base for co-driver' seat	SR9	○	○	£385.00	£462.00	
Technology	Tray for smartphones incl. wireless charging	E1B	○	○	£190.00	£228.00
	Digital radio (DAB)	E1D	●	●	–	–
	Digital Extra: Hard-disc navigation Includes Traffic Sign Assist and Pre-installation: Live Traffic Information.	E1E	○	○	£1,305.00	£1,566.00
	Digital Extra: Smartphone Integration Required for Apple CarPlay™ and Android Auto™ functionality. Requires pairing of the vehicle with a Mercedes-Benz ID.	E4S	●	●	–	–
	Charging package, dashboard	ES5	○	●	£55.00	£66.00
	MBUX multimedia system	E7M	●	●	–	–
	Communication module (LTE) for digital services	JH3	●	●	–	–
Instrument cluster with colour display	JK5	●	●	–	–	

Changes to individual option availability and combinations may occur depending on vehicle specification choices and the continuing evolution and adaptation of our product range. These changes may not be immediately reflected in this document as they occur, but will be introduced at the next revision opportunity.

Equipment (standard and optional overview).

● Standard ○ Optional — Not available



RETURN TO START

Category	Option Description	Option code	PRO	SELECT	Basic Price exc. VAT	Basic Price inc. VAT
Technology (cont.)	Plug socket in cab	E46	○	○	£75.00	£90.00
	USB socket, 5 V	E1U	●	●	—	—
Charging	Charging cable, mode 3 (type 2, 3x32A, 22kW), 5m	E2K	○	○	£430.00	£516.00
	Charging cable, mode 3 (type 2, 3x20A), 5m	E3K	○	○	£300.00	£360.00
	Charging cable, mode 3 (type 2, 3x20A), 8m	E8L	○	○	£345.00	£414.00
	Charging cable, mode 3 (type 2, 3x32A), 8m	E9L	●	●	—	—
	AC charging 11kW	E6A	●	●	—	—
	AC charging 22kW	E5A	○	○	£1,690.00	£2,028.00
	DC charging 115kW	E6J	●	●	—	—
Trim	All-weather floor mats	V3L	○	○	£60.00	£72.00
	Fabric Caluma black	VF4	○	○	£75.00	£90.00
	ARTICO man-made leather, black	VF6	○	○	£75.00	£90.00
	Fabric Maturin black	VF7	●	●	—	—
Keys	Multi-button remote control	FY7	○	○	£40.00	£48.00
	Two additional master keys	FZ9	○	○	£155.00	£186.00
Stowage	1-DIN SLOT under dashboard, passenger side	FE9	○	○	£105.00	£126.00
	Shelf above windscreen	FF5	●	●	—	—
	Single-size slot at front under roof liner	FF8	○	○	£105.00	£126.00
	Cup holders front	FG8	○	●	£40.00	£48.00
	Hinged lid for stowage compartment	FJ1	○	●	£120.00	£144.00
	Stowage compartment underneath cockpit	FJ4	●	●	—	—
	Hinged lid for stowage compartments left and right	FJ5	○	○	£130.00	£156.00
	Lockable unit in stow. compartment over windscreen	FQ6	○	○	£60.00	£72.00
	Stowage comp. above windscreen, driver side	FX0	○	○	-£40.00	-£48.00
	Stowage net on driver's seat backrest	SZ7	○	○	£60.00	£72.00
Stowage net on co-driver's seat backrest	SZ8	○	○	£60.00	£72.00	

Changes to individual option availability and combinations may occur depending on vehicle specification choices and the continuing evolution and adaptation of our product range. These changes may not be immediately reflected in this document as they occur, but will be introduced at the next revision opportunity.

Equipment (standard and optional overview).

● Standard ○ Optional — Not available



RETURN TO START

Category	Option Description	Option code	PRO	SELECT	Basic Price exc. VAT	Basic Price inc. VAT
Safety	Mercedes-Benz emergency call system	EY5	●	●	—	—
	Breakdown management	EY6	●	●	—	—
	Seat belt reminder for co-driver seat	J55	●	●	—	—
	Seat belt warning for driver's seat	J58	●	●	—	—
	Temperature indicator	J65	●	●	—	—
	Deactivation of bulb failure indicator	JW2	●	●	—	—
	Adaptive brake light	LE1	●	●	—	—
	Tyre pressure monitoring front/rear, wireless	RY2	●	●	—	—
	Thorax-pelvis sidebag, driver	SH1	○	○	£310.00	£372.00
	Thorax-pelvis sidebag, co-driver	SH2	○	○	£310.00	£372.00
	Windowbags for driver and co-driver	SH9	○	○	£890.00	£1,068.00
	Airbag, front driver's seat	SA5	●	●	—	—
	Airbag, co-driver	SA6	●	●	—	—
	Acoustic package	XM4	●	●	—	—
	First aid kit	Y10	○	○	£60.00	£72.00
	Chock (standard on 4.25T variants)	Y26	○	○	£55.00	£66.00
	Warning triangle	Y44	○	○	£40.00	£48.00
Wheels and Tyres	Provisional spare wheel mounting	R60	○	○	£55.00	£66.00
	Spare wheel bracket below frame end	R65	○	○	£105.00	£126.00
	Spare wheel	R87	○	○	£165.00	£198.00
	Full wheel cover	RD8	○	○	£85.00	£102.00
	Steel wheels, arctic white	RM2	○	○	£80.00	£96.00
	Steel wheels 6.5 J x 16	RS3	●	●	—	—
	Light alloy wheels 6.5 J x 16	RL5	○	○	£1,045.00	£1,254.00
	Hydraulic Jack	Y43	○	○	£75.00	£90.00
	Tyres without name of make	RD9	○	○	—	—
Make of tyres Continental (10)	RF1	●	●	—	—	

Changes to individual option availability and combinations may occur depending on vehicle specification choices and the continuing evolution and adaptation of our product range. These changes may not be immediately reflected in this document as they occur, but will be introduced at the next revision opportunity.

Equipment (standard and optional overview).

● Standard ○ Optional — Not available



RETURN TO START

Category	Option Description	Option code	PRO	SELECT	Basic Price exc. VAT	Basic Price inc. VAT
Wheels and Tyres (cont.)	Tyres 225/75 R16 C	RG8	●	●	—	—
	All-season tires	RM0	○	○	—	—
	M+S tyres	RM1	○	○	£95.00	£114.00
	Summer tyres	RM7	●	●	—	—
	Make of tyres as optional extra	RM9	○	○	£125.00	£150.00
	Tyres, resistance-optimised	RR0	●	●	—	—
	Front mud flaps	P47	○	●	£60.00	£72.00
Axle	Front axle with upgraded axle load	A50	●	●	—	—
Suspension	Rear underride protection EEC (standard on 4.25T variants)	C71	○	○	£240.00	£288.00
	Vehicle lowering	CA00	○	○	—	—
	Stabilisation level II	CB8	●	●	—	—
	Longitudinal member reinforcement	Q11	●	●	—	—
Grab handles	Grab handles for driver's and co-driver's doors	T75	○	○	£85.00	£102.00
	Grab handle for inner seat, two-seater	S78	○	○	£75.00	£90.00
Loading & Towing	Provision for retrofitting of loading tailgate	PV1	○	○	£50.00	£60.00
	Cross member for coupling	Q10	○	○	£420.00	£504.00
	End cross member bolted	Q18	○	○	£50.00	£60.00
	Trailer coupling, rigid coupling head	Q22	○	○	£670.00	£804.00
	Trailer coupling ball headed removable	Q50	○	○	£905.00	£1,086.00
	Towing eye rear	Q67	○	○	£30.00	£36.00
	Trailer socket, 13-pin	E43	○	○	£275.00	£330.00
	Electrical components for trailer socket	E57	●	●	—	—
	Electrical preinstallation for loading tailgate	EV3	○	○	£205.00	£246.00

Changes to individual option availability and combinations may occur depending on vehicle specification choices and the continuing evolution and adaptation of our product range. These changes may not be immediately reflected in this document as they occur, but will be introduced at the next revision opportunity.

Equipment (standard and optional overview).

● Standard ○ Optional — Not available



RETURN TO START

Category	Option Description	Option code	PRO	SELECT	Basic Price exc. VAT	Basic Price inc. VAT
Lighting	End-outline marker lamps	L07	●	●	—	—
	Lights for left hand traffic	L10	●	●	—	—
	Fog lamps with cornering light function	L13	○	○	£245.00	£294.00
	Partial LED tail lights	L22	○	○	£265.00	£318.00
	Directional indicators on front wings	L44	○	○	£135.00	£162.00
	Tail light wiring harness, extended	L76	○	○	£105.00	£126.00
	Additional electr. equipment for indicator lights	L77	○	○	£80.00	£96.00
	Pre-installation for LED rear lamps	L91	○	○	£60.00	£72.00
	Omission parking lamp	L94	○	○	—	—
	Highbeam Assist	LA1	○	●	£345.00	£414.00
	Headlight assistant A windscreen sensor continuously monitors light conditions and automatically switches the dipped beams on/off upon reaching pre-defined limits.	LA2	●	●	—	—
	Side marker lights	LB1	●	●	—	—
	Preparation for side marker lights	LB2	○	○	—	—
	Clearance light front LH, yellow	LB8	○	○	£375.00	£450.00
	Exit lamps	LB9	○	○	£75.00	£90.00
	LED High Performance headlamps	LG7	○	●	£1,780.00	£2,136.00
Pre-installation for 3rd brake light electrics	LV6	○	○	£30.00	£36.00	

Changes to individual option availability and combinations may occur depending on vehicle specification choices and the continuing evolution and adaptation of our product range. These changes may not be immediately reflected in this document as they occur, but will be introduced at the next revision opportunity.

Colours and upholstery.



RETURN TO START

Solid paints



Arctic White
(Standard on the eSprinter chassis cab)



Jupiter Red



Steel Blue



Jet Black

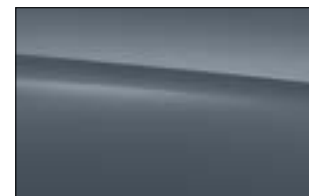

Blue Grey

Metallic paints



Tenorite Grey Metallic



Selenite Grey Metallic



Obsidian Black Metallic



High Tech Silver Metallic



Cavansite Blue Metallic

Interior upholstery



Maturin Black Fabric
seat upholstery

Due to limitations of on-screen representation, the vehicle colours may differ in reality to the on-screen images.

Charging Information.

Increasing efficiency and reducing downtime.

› The eSprinter can be charged by Direct Current (DC) or Alternating Current (AC).

AC is usually found at homes and workplaces and more cost effective for charging, however, generally requires longer intervals to fully charge. DC power can rapid-charge an electric vehicle using higher charging powers. For example, the eSprinter can accept 115kW of power.

- AC 7kW: 0-100% in ~12h 30 min†
- AC 11kW 0-100% in 8h 30 min (Wallbox)†
- AC 22kW 0-100% in 4h 30 min (Wallbox)†
- DC 115kW 10-80% in just 34 minutes†.

› Managing range and battery performance.

The eSprinter uses a process called recuperation that recovers energy when the vehicle is decelerating to help recharge the vehicle's battery. There are 5 recuperation modes available, which can be adjusted via the steering-wheel paddles. The greater the recuperation level, the faster you decelerate and therefore, the more energy your vehicle will recover. An automatic mode is also fitted as standard, D AUTO, which uses the radar-sensor to intelligently select the best mode for a given driving situation.

- D-** This mode will enable you to get maximum range from your eSprinter. It has maximum recuperation and fastest deceleration. Due to the deceleration being so strong, your vehicle will automatically activate your brake lights when you lift off the accelerator.
- D** This mode has less recuperation than D- and has similar deceleration levels to a diesel Sprinter.
- D+** This mode has significantly lower recuperation levels and therefore will decelerate at a slower rate than a diesel Sprinter. D+ is a coasting mode, meaning your vehicle will have no recuperation and can 'sail' for example when driving for long periods downhill.
- D++** No recuperation and slowest deceleration.

† Charging times are for the 81kWh eSprinter chassis. Charging times are subject to the power available at the location where the vehicle will be charged as well as factors such as temperature, charge point and type of cable used.

^ Mercedes-Benz research analysed 1.6 million journeys anonymously on the EQ Ready app and 96% of all journeys recorded were shorter than 100km (62 miles).



Did you know the average van across the UK and Europe travels less than 62 miles[^] a day?

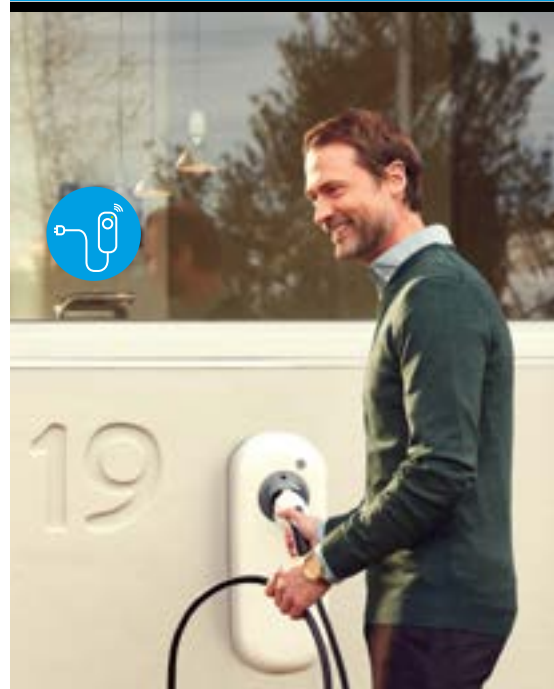

The New Mercedes-Benz eSprinter

Technical Data - Battery and e-Motor.



RETURN TO START

System specifications

Fuel	Electric
Output, max.	100kW
Output, max.	136 PS
Torque, max.	400 Nm
Drive	RWD
Battery Composition	LFP (Lithium iron phosphate)
Battery Capacity	81kWh / 113kWh
Battery Voltage	400
Battery Charging	AC: 11kW / AC: 22kW / DC: 115kW
Battery Charging Time	113kWh: AC (11kW) 0-100% - 11:15 (wallbox)/ AC (22kW) 0-100% - 06:00 (wallbox)/ DC (115kW) 10-80% - 42 min 81kWh: AC (11kW) 0-100% - 08:30 (wallbox)/ AC (22kW) 0-100% - 04:30 (wallbox)/ DC (115kW) 10-80% - 34 min
Service Interval	1 year/24,000 miles
Battery Capacity Warranty	8 years/100,000 miles

System specifications

Fuel	Electric
Output, max.	150kW
Output, max.	204 PS
Torque, max.	400 Nm
Drive	RWD
Battery Composition	LFP (Lithium iron phosphate)
Battery Capacity	81kWh / 113kWh
Battery Voltage	400
Battery Charging	AC: 11kW / AC: 22kW / DC: 115kW
Battery Charging Time	113kWh: AC (11kW) 0-100% - 11:15 (wallbox)/ AC (22kW) 0-100% - 06:00 (wallbox)/ DC (115kW) 10-80% - 42 min 81kWh: AC (11kW) 0-100% - 08:30 (wallbox)/ AC (22kW) 0-100% - 04:30 (wallbox)/ DC (115kW) 10-80% - 34 min
Service Interval	1 year/24,000 miles
Battery Capacity Warranty	8 years/100,000 miles



[RETURN TO START](#)

Technical Data - WLTP Range, CO₂ emissions and Electrical Consumption.

All-electric WLTP Range (mi/km)	CO ₂ emissions, combined, (g/km)	Combined	Low (extra-urban)	Medium (urban)	High (rural)	Extra-high (motorway)
81kWh eSprinter 314 Chassis L2 PRO	0	170/273	TBC	TBC	TBC	TBC
81kWh eSprinter 314 Chassis L3 PRO	0	169/272	TBC	TBC	TBC	TBC
81kWh eSprinter 320 Chassis L2 PRO	0	171/276	TBC	TBC	TBC	TBC
81kWh eSprinter 320 Chassis L3 PRO	0	171/274	TBC	TBC	TBC	TBC
81kWh eSprinter 320 Chassis L2 SELECT	0	171/275	TBC	TBC	TBC	TBC
81kWh eSprinter 320 Chassis L3 SELECT	0	170/274	TBC	TBC	TBC	TBC
81kWh eSprinter 414 Chassis L2 PRO	0	187/301	TBC	TBC	TBC	TBC
81kWh eSprinter 414 Chassis L3 PRO	0	187/301	TBC	TBC	TBC	TBC
81kWh eSprinter 420 Chassis L2 PRO	0	188/303	TBC	TBC	TBC	TBC
81kWh eSprinter 420 Chassis L3 PRO	0	188/303	TBC	TBC	TBC	TBC
113kWh eSprinter 414 Chassis L3 PRO	0	272/437	TBC	TBC	TBC	TBC
113kWh eSprinter 420 Chassis L3 PRO	0	274/441	TBC	TBC	TBC	TBC
113kWh eSprinter 420 Chassis L3 SELECT	0	274/441	TBC	TBC	TBC	TBC

The indicated values were determined according to the prescribed measurement method - Worldwide Harmonised Light Vehicle Test Procedure (WLTP). Battery Electric Vehicles (BEV) require mains electricity for charging, range figures determined with the battery fully charged. Figures shown are for comparability purposes; only compare with other cars tested to the same technical procedure (WLTP). Figures may not reflect real life driving results, which will depend upon a number of factors including the starting charge of the battery, factory-fitted options, accessories fitted (post registration), variations in weather, driving styles and vehicle load. Further information about the test used to establish range, power consumption and CO₂ figures can be found at <http://www.mercedes-benz.co.uk/WLTP>. For real time data visit https://voc.mercedes-benz.com/voc/gb_en.

Technical Data - WLTP Range, CO₂ emissions and Electrical Consumption.



RETURN TO START

Electrical consumption (kWh/100km)	CO ₂ emissions, combined, (g/km)	Combined	Low (extra-urban)	Medium (urban)	High (rural)	Extra-high (motorway)
81kWh eSprinter 314 Chassis L2 PRO	0	32.7	17.8	21.3	28.7	50.9
81kWh eSprinter 314 Chassis L3 PRO	0	32.8	18.0	21.5	28.9	51.0
81kWh eSprinter 320 Chassis L2 PRO	0	32.2	17.2	20.7	29.0	47.5
81kWh eSprinter 320 Chassis L3 PRO	0	32.4	17.4	20.9	29.1	47.5
81kWh eSprinter 320 Chassis L2 SELECT	0	32.3	17.2	20.7	29.0	47.5
81kWh eSprinter 320 Chassis L3 SELECT	0	32.4	17.4	20.9	29.1	47.6
81kWh eSprinter 414 Chassis L2 PRO	0	28.2	18.1	21.8	28.7	36.3
81kWh eSprinter 414 Chassis L3 PRO	0	28.2	18.1	21.8	28.7	36.3
81kWh eSprinter 420 Chassis L2 PRO	0	28.0	18.4	21.6	28.7	34.4
81kWh eSprinter 420 Chassis L3 PRO	0	28.0	18.4	21.6	28.7	34.3
113kWh eSprinter 414 Chassis L3 PRO	0	28.4	18.7	22.4	29.1	35.7
113kWh eSprinter 420 Chassis L3 PRO	0	28.5	19.1	22.9	29.3	34.7
113kWh eSprinter 420 Chassis L3 SELECT	0	28.5	19.1	22.9	29.3	34.8

The indicated values were determined according to the prescribed measurement method - Worldwide Harmonised Light Vehicle Test Procedure (WLTP). Battery Electric Vehicles (BEV) require mains electricity for charging, range figures determined with the battery fully charged. Figures shown are for comparability purposes; only compare with other cars tested to the same technical procedure (WLTP). Figures may not reflect real life driving results, which will depend upon a number of factors including the starting charge of the battery, factory-fitted options, accessories fitted (post registration), variations in weather, driving styles and vehicle load. Further information about the test used to establish range, power consumption and CO₂ figures can be found at <http://www.mercedes-benz.co.uk/WLTP>. For real time data visit https://voc.mercedes-benz.com/voc/gb_en.

Technical Data – Payload and Weights.



RETURN TO START

Model	Gross Vehicle Weight (Kg)	Payload (Kg)	Kerb weight, with driver (Kg)*	Gross Combination Weight (Kg)
81kWh eSprinter 314 Chassis L2 PRO	3500	1084	2416	5000
81kWh eSprinter 314 Chassis L3 PRO	3500	1055	2445	5000
81kWh eSprinter 320 Chassis L2 PRO	3500	1084	2416	5000
81kWh eSprinter 320 Chassis L3 PRO	3500	1055	2445	5000
81kWh eSprinter 320 Chassis L2 SELECT	3500	1078	2422	5000
81kWh eSprinter 320 Chassis L3 SELECT	3500	1049	2451	5000
81kWh eSprinter 414 Chassis L2 PRO	4250	1805	2445	5000
81kWh eSprinter 414 Chassis L3 PRO	4250	1776	2474	5000
81kWh eSprinter 420 Chassis L2 PRO	4250	1805	2445	5000
81kWh eSprinter 420 Chassis L3 PRO	4250	1776	2474	5000
113kWh eSprinter 414 Chassis L3 PRO	4250	1555	2695	5000
113kWh eSprinter 420 Chassis L3 PRO	4250	1555	2695	5000
113kWh eSprinter 420 Chassis L3 SELECT	4250	1549	2701	5000

All weights and dimensions quoted are subject to normal manufacturing tolerances of +/- 5%. Stated weight figures in accordance with Directive 97/27/EC in the applicable version at the time of going to print. Stated weight figures are for UK supplied vehicles and include charging cable and all standard equipment. The figures are not based on an individual vehicle and do not constitute part of the product offer; they are provided solely for the purposes of comparison between different vehicle models. The payload figures depend on the optional equipment fitted to the vehicle, please contact your Mercedes-Benz Retail Partner for an individual vehicle calculation. Payload figures include the standard mode3 charging cable (5kg).

Dimensions.



RETURN TO START

PRO/SELECT L2*

Wheelbase	Wheelbase length	3,665mm
	Turning circle	13.3m
	Front track width	1,726mm
	Rear track width	1,732mm
Vehicle	Length (inc. tread)	5,886mm
	Height (unladen)	2,355mm
	Width (inc. wing mirrors)	2,345mm
	Width (inc. extended wing mirrors)	2,667mm

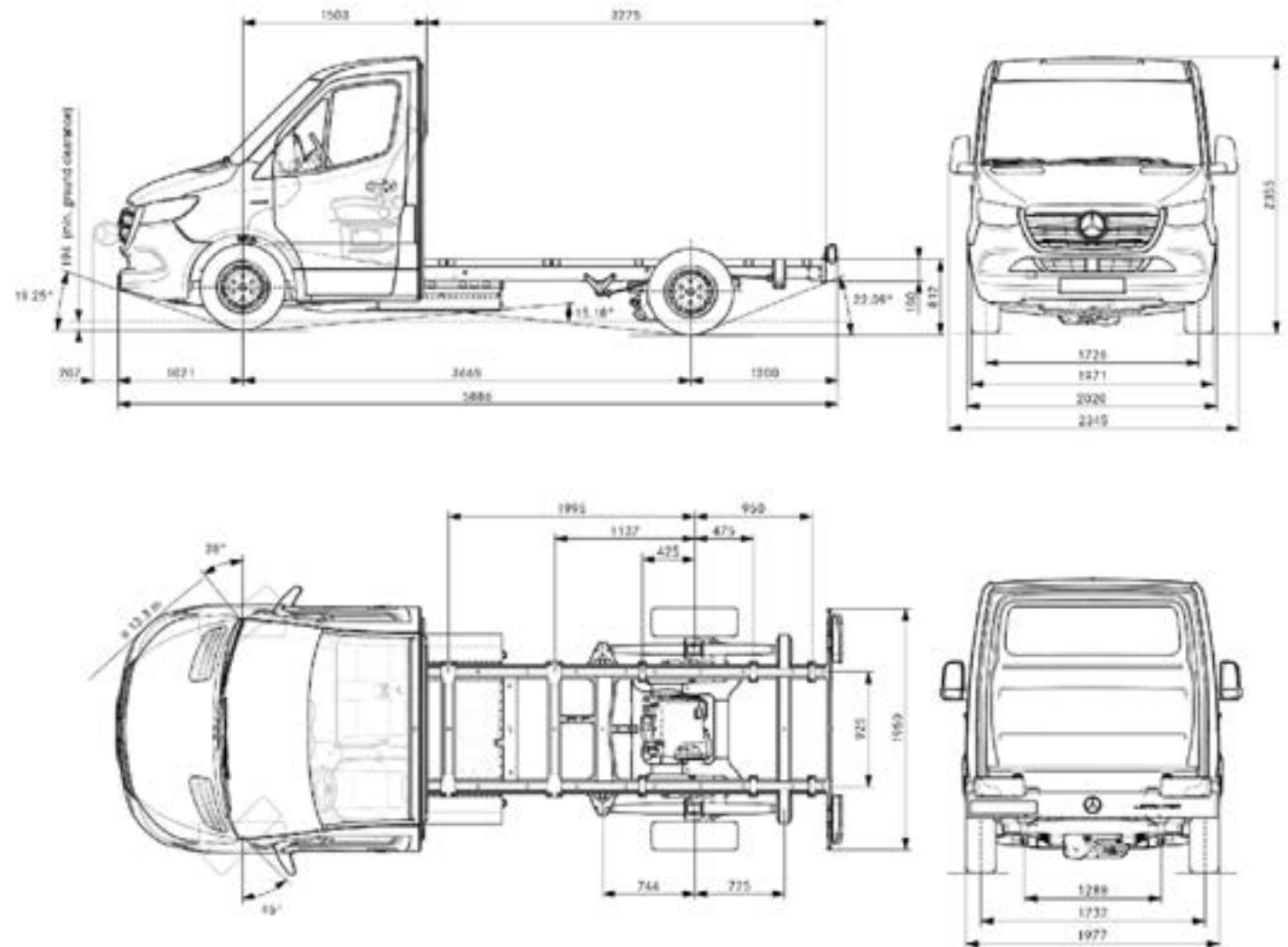

*Dimensions could vary according to variant, please consult your local dealer.

Dimensions.



RETURN TO START

PRO/SELECT L3*

Wheelbase	Wheelbase length	4,325mm
	Turning circle	15.3m
	Front track width	1,726mm
	Rear track width	1,732mm
Vehicle	Length (inc. tread)	6,696mm
	Height (unladen)	2,344mm
	Width (inc. wing mirrors)	2,345mm
	Width (inc. extended wing mirrors)	2,667mm

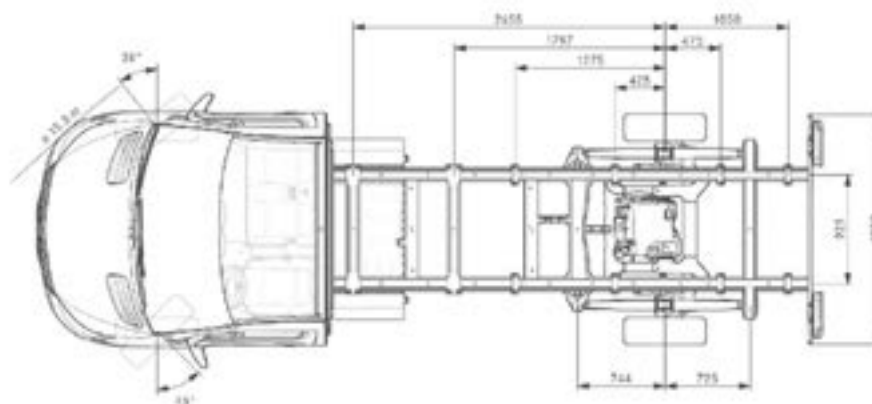
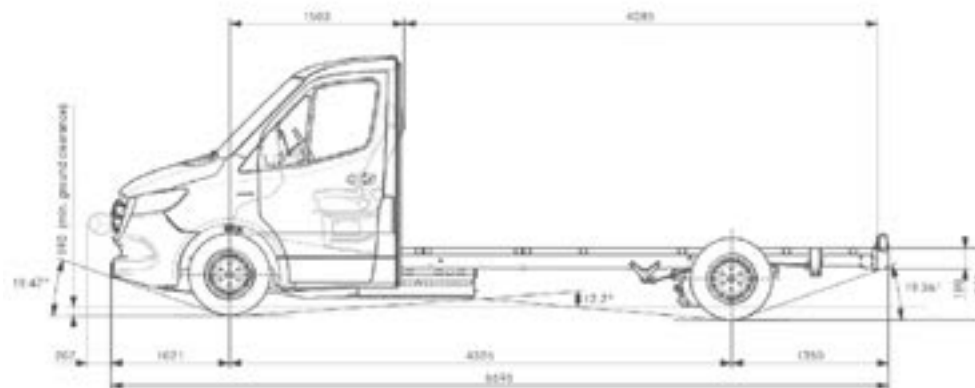

*Dimensions could vary according to variant, please consult your local dealer.

Mercedes-Benz Electric Vans and the Environment.



RETURN TO START

A key advantage of any battery electric vehicle (BEV) is its positive environmental impact, compared to an internal combustion (ICE) vehicle. Mercedes-Benz electric vans produce no tailpipe emissions.

See right for the Energy Efficiency Rating and emission standards compliance.

Environmental data, Mercedes-Benz electric vans

CO₂ is the main greenhouse gas responsible for climate change.

0	A	Rating: A 0g/km
1-50	A	
51-75	B	
76-90	C	
91-100	D	
101-110	E	
111-130	F	
131-150	H	
151-170	I	
171-190	J	
191-225	K	
226-255	L	
256+	M	

Emission standards

ULEV ✓
Ultra Low Emission Vehicle **ULEV**

ZEV ✓
Zero Tailpipe Emissions Vehicle **ZEV**

Air quality emission zone compliance

ULEV ✓
Clean Air Zones
(England and Wales) **CAZ**

ULEZ ✓
Ultra Low Emission Zone
(London) **ULEZ**

This vehicle(s) meets the emissions standard for private vans set by government under the Clean Air Zone (CAZ) framework for England and Wales currently in place until 2025. Stricter CAZ standards and restrictions could then apply. Some local authorities may also impose more stringent controls in certain areas. A ULEV meets the current government standard for an Ultra Low Emission Vehicle, stricter standards could apply in the future. See more about future CAZs [here](#).

Ambition 2039

A core element of our sustainable business strategy is Ambition 2039, with which we already set the course in 2019 for a holistic approach to climate protection and air pollution control.

The ambition is to make our entire fleet of new vehicles net carbon-neutral along the entire value chain and over the vehicles' entire life cycle by 2039 – from development to the supplier network, in-house production, electrification of products to renewable energies in the use phase of electric vehicles and recycling of the vehicles to close the loop.



The Mercedes-Benz App on new eSprinter.



RETURN TO START

Monitor your van's status, location and security via your smartphone.



ASSISTANCE & AFTERCARE		FREE
Telediagnosics & Maintenance Management	Receive a notification when wear is detected on diagnostic-capable parts such as brake pads and get advance notice of when a service is due allowing you to plan your workshop visit well in advance to minimise any impact on your business.	
Remote Vehicle Diagnostics	Your Dealer can assess your van's condition remotely allowing them to check if any other repairs are required ahead of a service.	
Accident Recovery & Breakdown Management	Once an emergency call has been resolved or if you request breakdown assistance, further support is offered to help recover your van or to tow it to a Mercedes-Benz Service outlet.	
Software updates	Over-the-air software updates are sent directly to your van's head unit. This means you'll always know your software is up to date and you'll save time by avoiding additional workshop visits.	
VEHICLE SUPERVISION		FREE FOR 3 YEARS
Vehicle Tracker	See your van's location on the map in your app, making it easy to call or message your driver and re-route them to fit in another delivery or pick-up if a quicker route is available. The tracker is factory fitted equipment so it can't be easily removed if stolen.	
Parked Vehicle Locator	If you're within 1 mile of your van's parked location, the app can generate the most convenient walking route - very handy if you're in unfamiliar surroundings and on a busy schedule.	
REMOTE ACCESS		FREE FOR 3 YEARS
Remote Retrieval of Vehicle Status	Use your app to check on charge level, tyre pressure, mileage and trip information. Not only does this help you plan your day's journeys, it can save you admin time on tasks such as logging your mileage for expenses.	
Remote Door Locking & Unlocking	The app allows you to check if your van is locked. If you lock your keys in the van or need to give another driver access, you can do it via the app, from any distance away. For added peace of mind, you'll receive an email notification when your vehicle is unlocked.	
EV SERVICES		FREE
Pre-Entry Climate Control	Climate control can be started remotely when your van is charging so energy used for heating will draw on the mains power to avoid depleting your battery. This means you'll have maximum comfort and battery range.	
Display of Charging Stations & Range on map	The Mercedes-Benz App shows you charging stations in the surrounding area and enables you to set the preferred one as your destination. The range display in your app helps you plan a journey with confidence as it shows if you can reach your destination using your existing battery range.	

Mercedes-Benz Approved Used Electric vans. Get used to more...

More choice. More confidence. More quality – and more added extras.

As a Mercedes-Benz Approved Used Electric customer, you'll have complete peace of mind as every van offers the same commitment to quality and workmanship as new and comes with:



12-24 month warranty option*



Free MOT test failure cover** covering you for £1,500

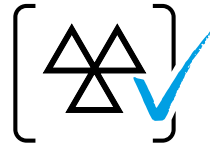

Minimum 3 months MOT



Free 24/7 breakdown cover and roadside assistance^



Comprehensive multi-point vehicle check

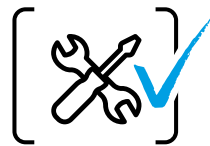

Discounted service plans

* Warranty eligible up to 200,000 miles on approved used Mercedes-Benz Vans with less than 150,000 miles at point of sale. For full T&Cs, please speak to your preferred sales representative. ** MOT cover redeemable per 12-months warranty. £1,500 claims limit. For more information, please speak to your preferred sales representative. ^ Free for 12 months initially and renewed at each service, if serviced by MB according to service intervals for up to 30 years from when the vehicle was first registered. For a full list of exclusions and all product terms please visit mbvans.co.uk/mobilovan For full terms and conditions, please consult your local Dealer. Mercedes-Benz Van Insurance is a trading name of Mercedes-Benz Insurance Services UK Limited. Prices are correct at time of going to press 01/2026. All prices are subject to any fiscal or legislative changes.



RETURN TO START

Approved
Used
Electric



What is an Approved Used van?

- Is no older than 6 years old
- Has less than 150,000 miles on the clock
- Is eligible for one of our flexible finance plans

➤ [Find more information and our latest Approved Used Electric offers](#)

What is an Approved Used Electric van?

➤ [Visit our Dealer Networks Approved Used Electric van stock](#)

The New Mercedes-Benz eSprinter

28



RETURN TO START

All eSprinter models include an Integrated Service Package (ISP).

Integrated Service Package (ISP), helps to form an integral part of our commitment that the eSprinter is not only performing well but is safe to operate at all times.

Our ISP consists of four services: two A (minor) and two B (major) services as standard – and can be transferred to a new owner. All of our electric vehicles also come with out of charge cover and an 8 year/100,000 mile battery capacity warranty as standard.



Service24: Demand more.

The most comprehensive Aftercare package – for businesses that demand more.

Our 120-strong Dealer network works around the clock to service and maintain your vans and keep your business moving. It all adds up to more value, more flexibility and more confidence that you'll only find at an authorised Mercedes-Benz Dealer.



› Flexible servicing and maintenance

Book your service online or by telephone, and as well as a standard 'drop and go' service with a courtesy van, you'll also get:

- Early bird, late night and weekend slots
- Mobile service
- Overnight service
- Collect & deliver service
- Express 1hr service
- Electric van service.

[Find out more about service and repairs](#)



› Flexible ways to pay and save

With fixed, transparent national pricing there are no surprises with our services and repairs – plus you can fix, spread and reduce your service and maintenance costs, and ease your cashflow at the same time, with a payment plan.

- Pay as You Go
- ServiceCare Maintenance
- ServiceCare Complete.

[Find out more about service options](#)



› 3-year unlimited mileage warranty

Available on every new van, all service and maintenance – and any work required – is covered by your 3-year unlimited mileage warranty, and is only undertaken by Mercedes-Benz trained technicians using Mercedes-Benz GenuineParts.

› 8 year/100,000 mile Battery Capacity Warranty

For peace of mind and reliable performance, the eSprinter's battery comes with an impressive 8 year/100,000 mile battery guarantee.

[Find out more about warranties](#)

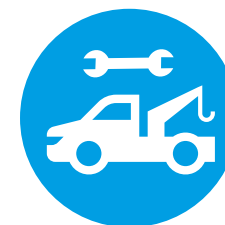

› Free breakdown cover & roadside assistance*

Every van comes with free Europe-wide breakdown cover – MobiloVan. And with 3 years' cover on new vehicles for driver mishaps, no one goes further to keep your business moving.

- Trained technicians using only Mercedes-Benz GenuineParts
- Out of charge cover for electric vehicles
- Forward travel of load and crew is covered
- Driver mishap cover for the first 3 years, including out of charge cover or empty fuel tanks.

[Find out more about MobiloVan](#)

*For a full list of exclusions and all product terms please visit www.mercedes-benz.co.uk/vans/en/Owners/MobiloVan

The New Mercedes-Benz eSprinter 30

January 2026

Mercedes-Benz UK Limited, Delaware Drive, Tongwell, Milton Keynes, MK15 8BA. Company number: 02448457

www.mercedes-benz.co.uk